



# IJF Grandprix Rotterdam 2010

(NED Rotterdam, 15-17 October 2010)

# -60 kg

26 Judoka

Pool A

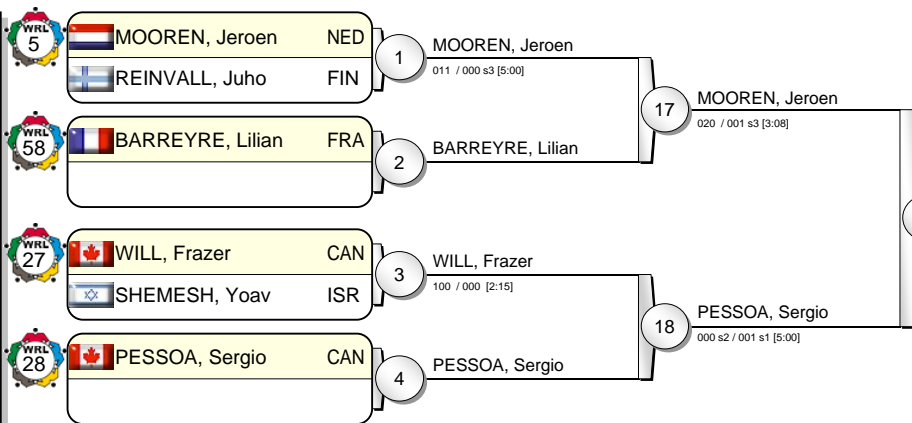

Pool B

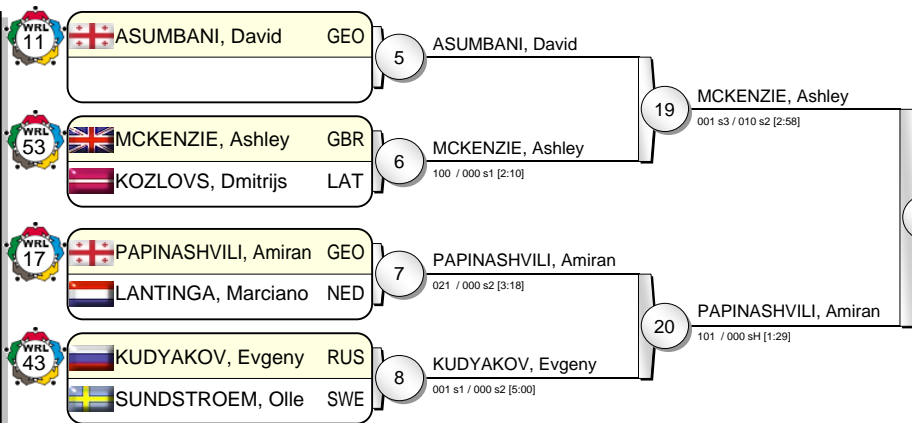

Pool C

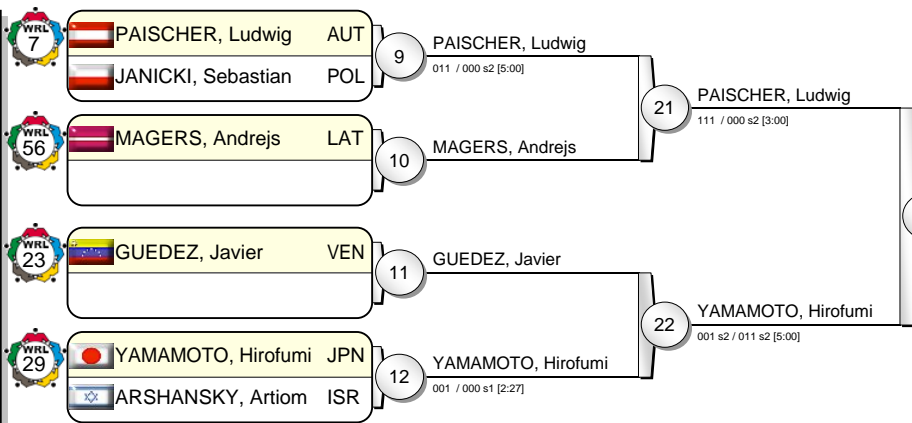

Pool D

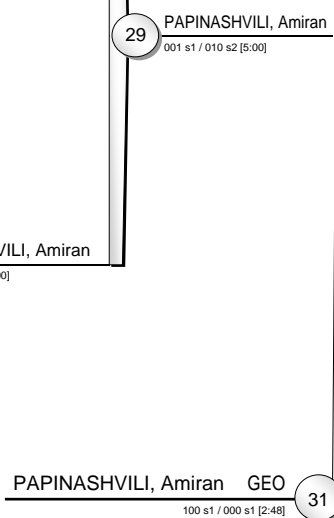
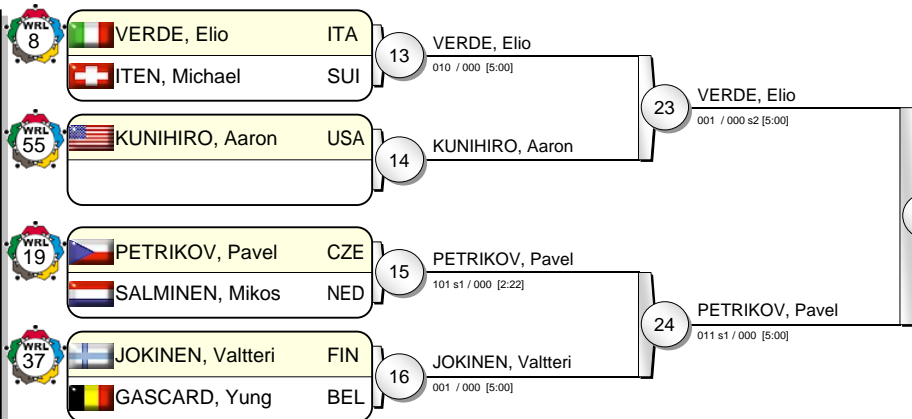

PAPINASHVILI, Amiran GEO

100 s1 / 000 s1 [2:48]

31

## Results

- |    |                      |     |  |
|----|----------------------|-----|--|
| 1. | PAPINASHVILI, Amiran | GEO |  |
| 2. | PAISCHER, Ludwig     | AUT |  |
| 3. | PESSOA, Sergio       | CAN |  |
| 3. | VERDE, Elio          | ITA |  |
| 5. | MOOREN, Jeroen       | NED |  |
| 5. | MCKENZIE, Ashley     | GBR |  |
| 5. | YAMAMOTO, Hirofumi   | JPN |  |
| 5. | PETRIKOV, Pavel      | CZE |  |





# IJF Grandprix Rotterdam 2010

(NED Rotterdam, 15-17 October 2010)

# -66 kg

26 Judoka

Pool A

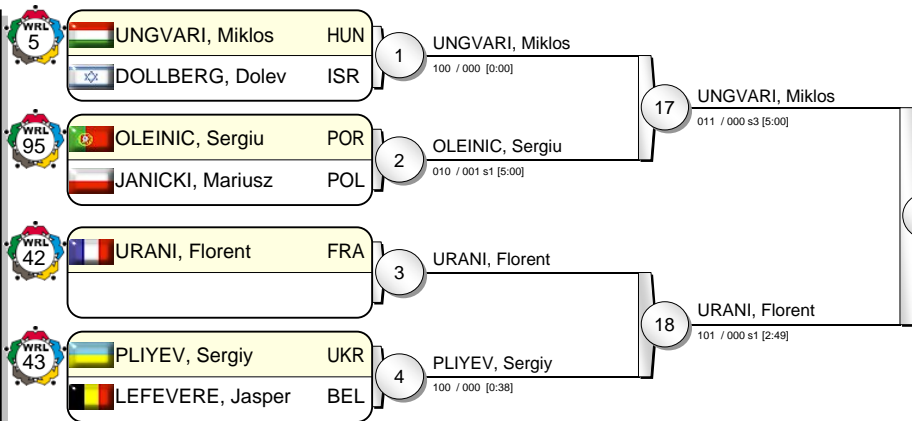

Pool B

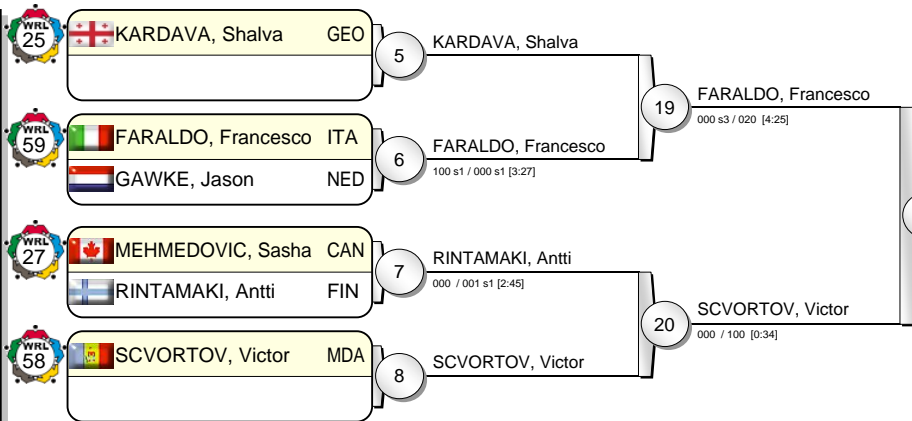

Pool C

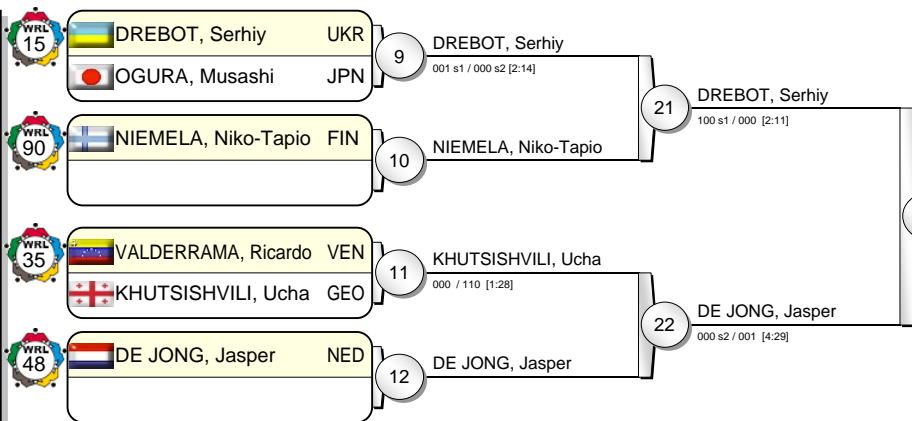

Pool D

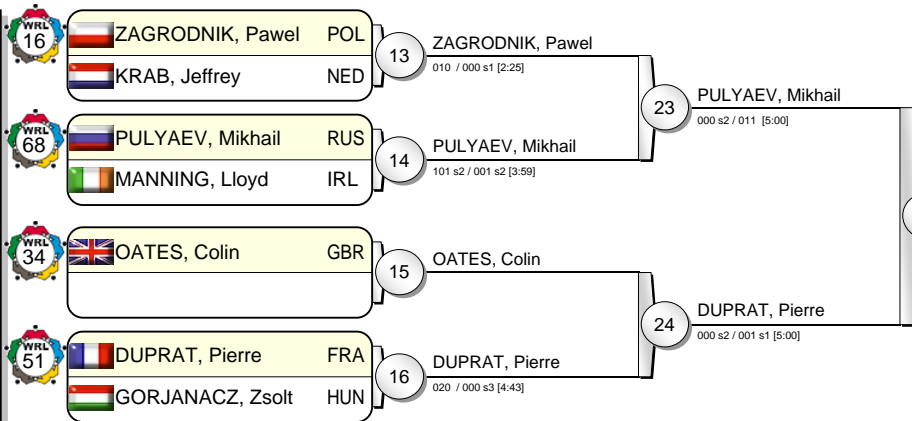

PULYAEV, Mikhail RUS 31  
001 s2 / 002 s2 [5:00]

## Results

- |    |                    |     |  |
|----|--------------------|-----|--|
| 1. | PULYAEV, Mikhail   | RUS |  |
| 2. | FARALDO, Francesco | ITA |  |
| 3. | UNGVARI, Miklos    | HUN |  |
| 3. | DREBOT, Serhiy     | UKR |  |
| 5. | URANI, Florent     | FRA |  |
| 5. | SCVORTOV, Victor   | MDA |  |
| 5. | DE JONG, Jasper    | NED |  |
| 5. | DUPRAT, Pierre     | FRA |  |





# IJF Grandprix Rotterdam 2010

(NED Rotterdam, 15-17 October 2010)

# -73 kg

32 Judoka

Pool A

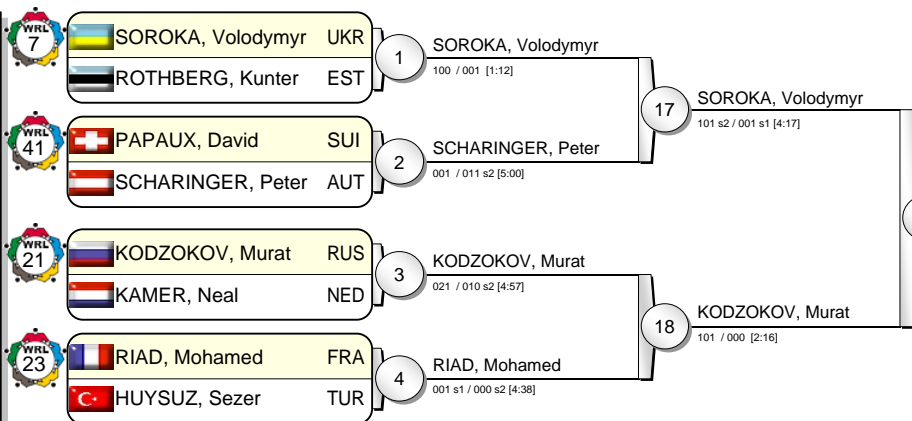

Pool B

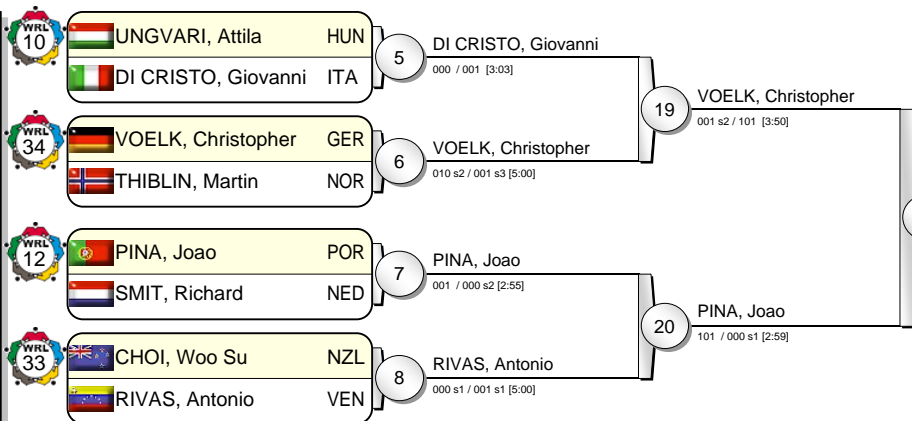

Pool C

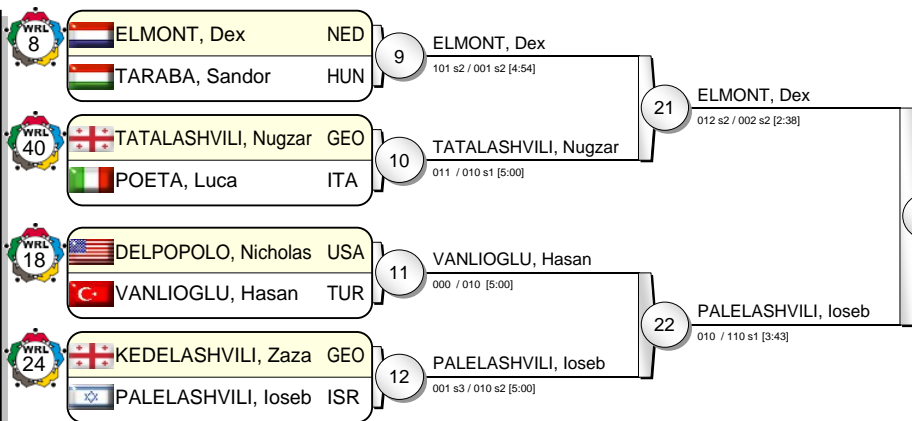

Pool D

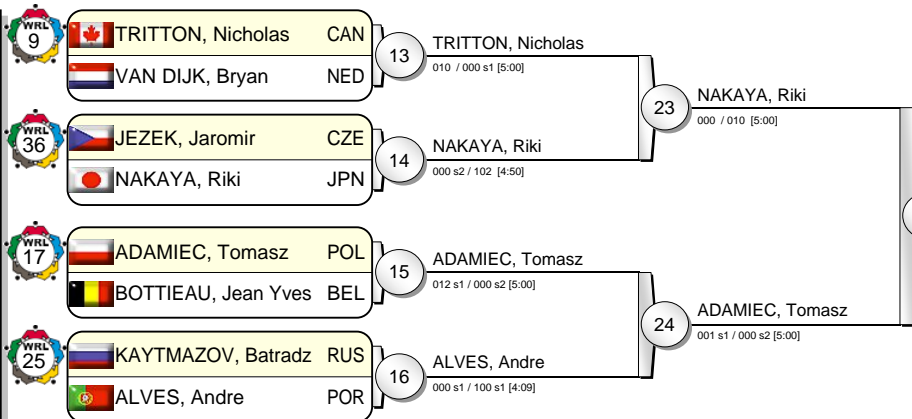

PINA, Joao POR 31  
002 / 000 [5:00]

## Results

- |                        |     |  |
|------------------------|-----|--|
| 1. PINA, Joao          | POR |  |
| 2. ELMONT, Dex         | NED |  |
| 3. KODZOKOV, Murat     | RUS |  |
| 3. ADAMIEC, Tomasz     | POL |  |
| 5. SOROKA, Volodymyr   | UKR |  |
| 5. VOELK, Christopher  | GER |  |
| 5. PALELASHVILI, Ioseb | ISR |  |
| 5. NAKAYA, Riki        | JPN |  |



# IJF Grandprix Rotterdam 2010

(NED Rotterdam, 15-17 October 2010)

# -81 kg

38 Judoka

Pool A

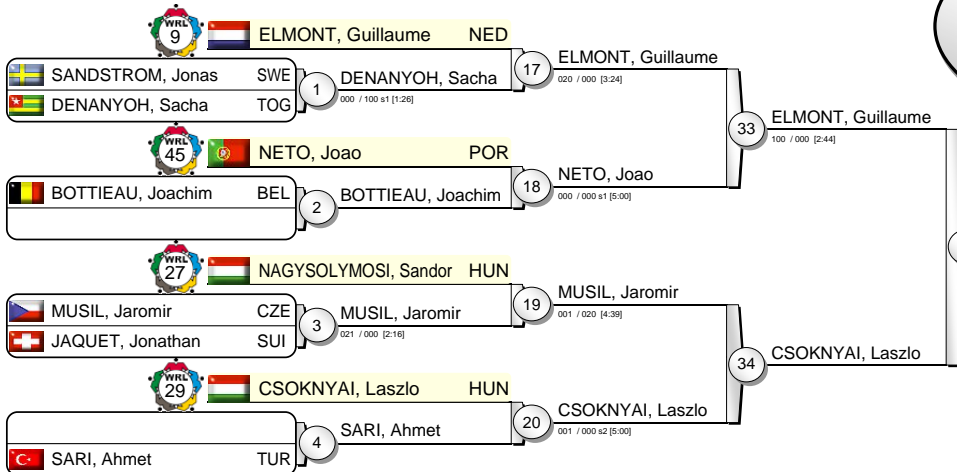

Pool B

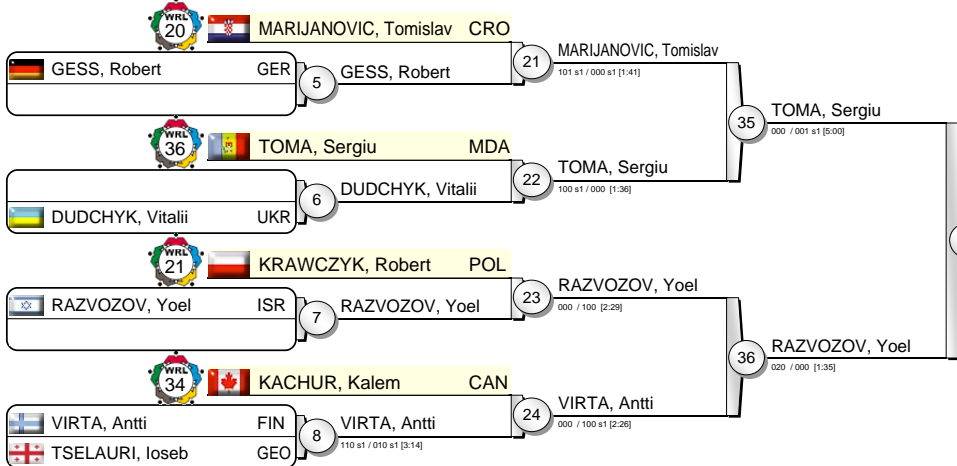

Pool C

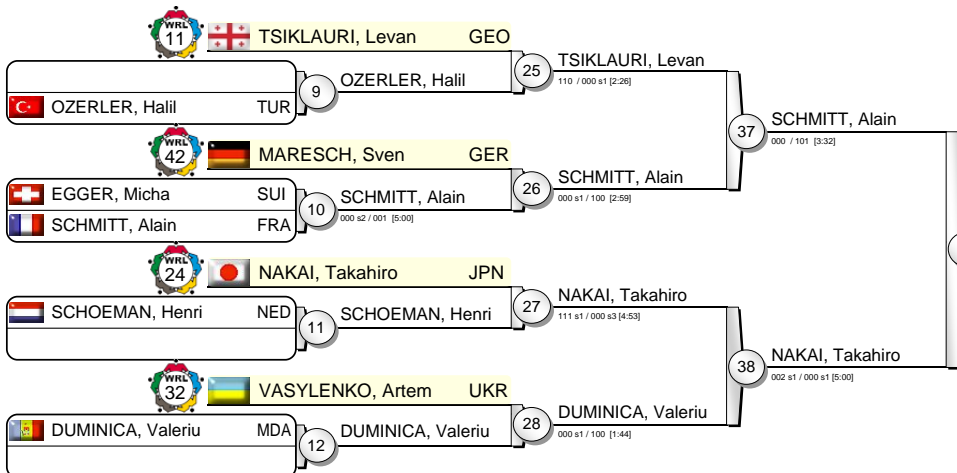

Pool D

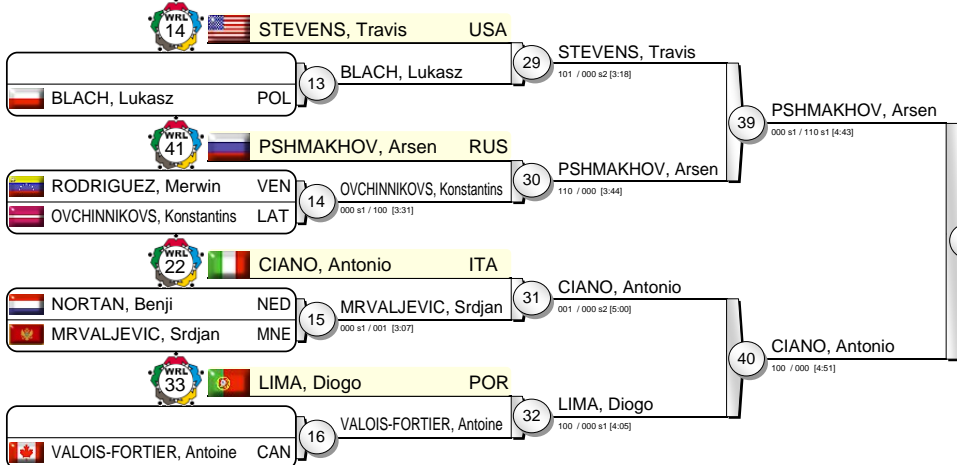

ELMONT, Guillaume (47) 100 / 000 [2:33]

## Results

- ELMONT, Guillaume NED
- NAKAI, Takahiro JPN
- TOMA, Sergiu MDA
- CIANO, Antonio ITA
- CSOKNYAI, Laszlo HUN
- RAZVOZOV, Yoel ISR
- SCHMITT, Alain FRA
- PSHMAKHOV, Arsen RUS





# IJF Grandprix Rotterdam 2010

(NED Rotterdam, 15-17 October 2010)

# -90 kg

23 Judoka

Pool A

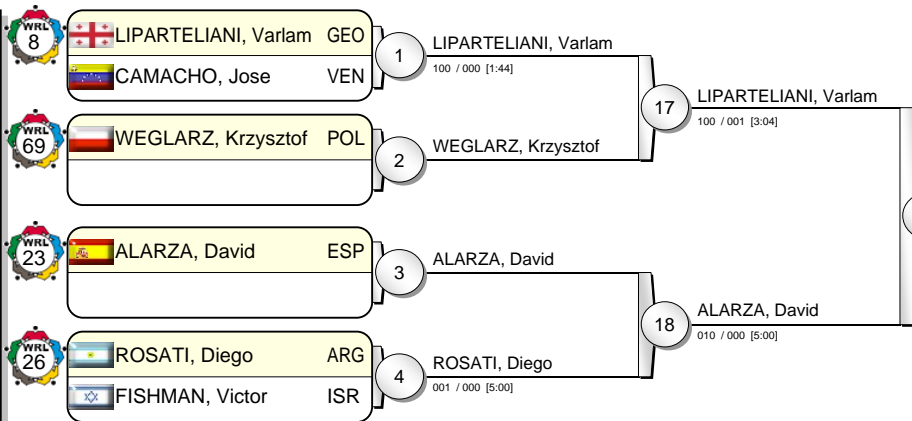

Pool B

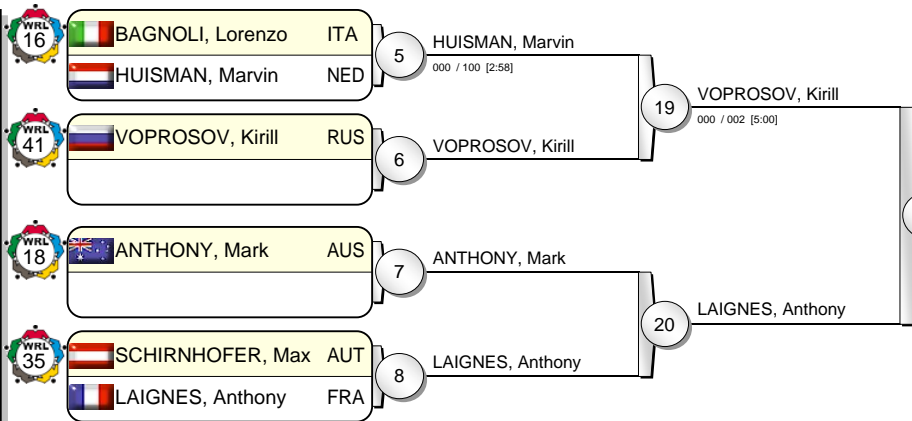

Pool C

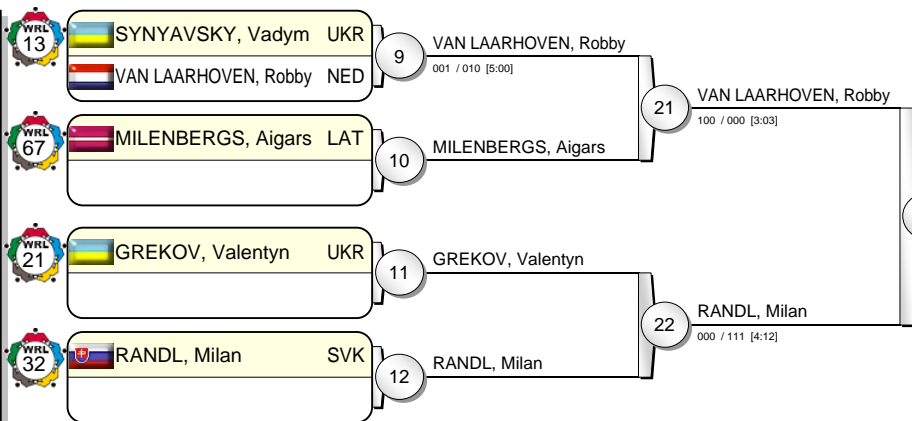

Pool D

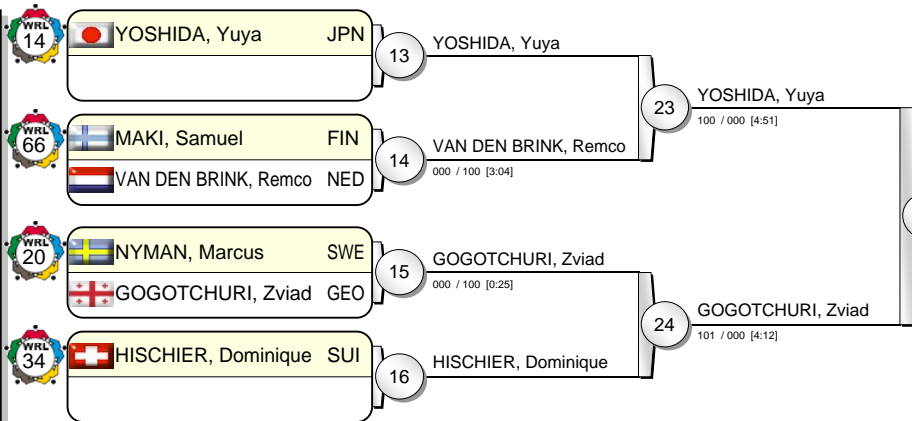

YOSHIDA, Yuya JPN 31

30 YOSHIDA, Yuya 000 / 100 [1:12]

## Results

- |                         |     |  |
|-------------------------|-----|--|
| 1. YOSHIDA, Yuya        | JPN |  |
| 2. LIPARTELIANI, Varlam | GEO |  |
| 3. VOPROSOV, Kirill     | RUS |  |
| 3. RANDL, Milan         | SVK |  |
| 5. ALARZA, David        | ESP |  |
| 5. LAIGNES, Anthony     | FRA |  |
| 5. VAN LAARHOVEN, Robby | NED |  |
| 5. GOGOTCHURI, Zviad    | GEO |  |





# IJF Grandprix Rotterdam 2010

(NED Rotterdam, 15-17 October 2010)

# -100 kg

13 Judoka

Pool A

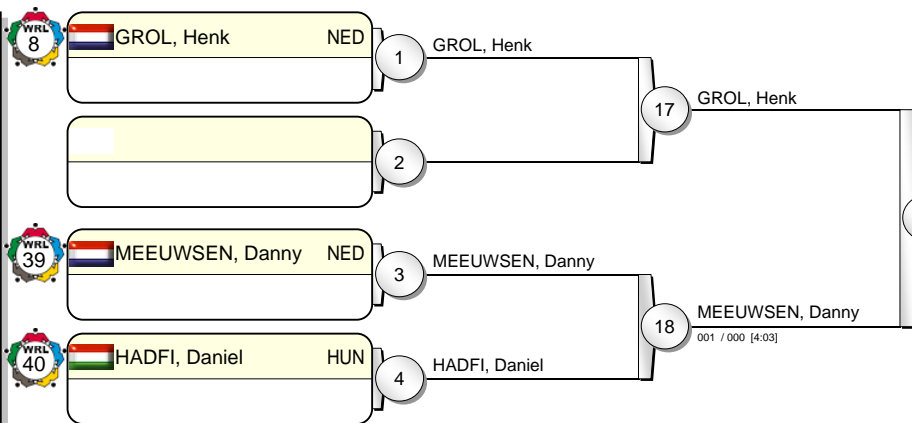

Pool B

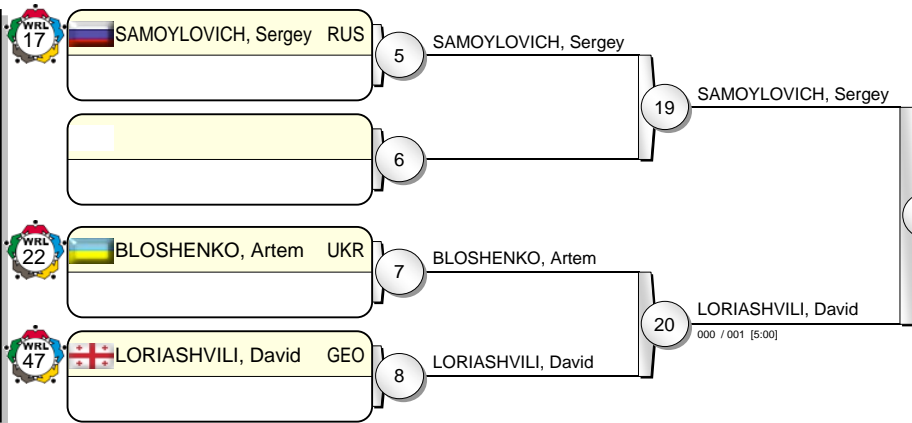

Pool C

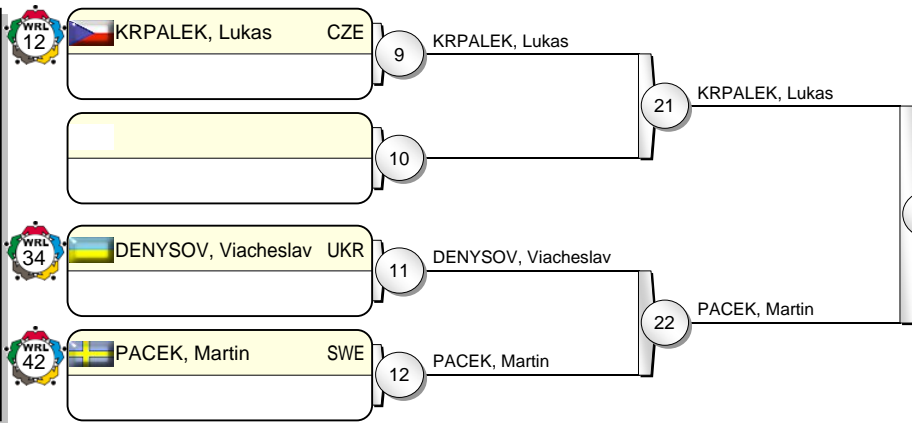

Pool D

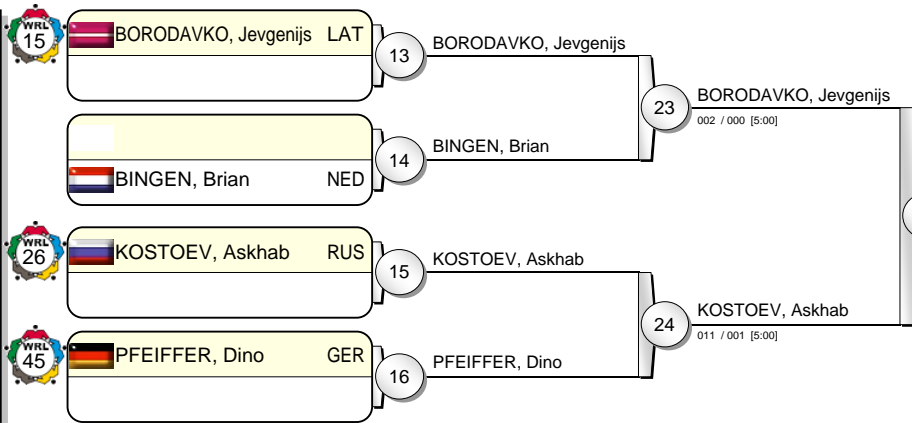

GROL, Henk NED 31  
0:01 / 0:00 [5:00]

BORODAVKO, Jevgenijs 30  
0:00 / 0:20 [4:48]

## Results

- |    |                      |     |  |
|----|----------------------|-----|--|
| 1. | GROL, Henk           | NED |  |
| 2. | BORODAVKO, Jevgenijs | LAT |  |
| 3. | SAMOYLOVICH, Sergey  | RUS |  |
| 3. | PACEK, Martin        | SWE |  |
| 5. | MEEUWSEN, Danny      | NED |  |
| 5. | LORIASHVILI, David   | GEO |  |
| 5. | KRPALEK, Lukas       | CZE |  |
| 5. | KOSTOEV, Askhab      | RUS |  |





# IJF Grandprix Rotterdam 2010

(NED Rotterdam, 15-17 October 2010)

# +100 kg

12 Judoka

Pool A

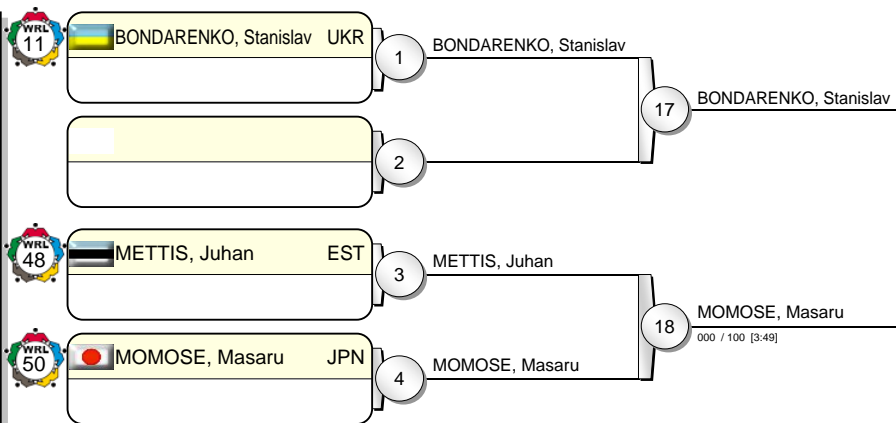

Pool B

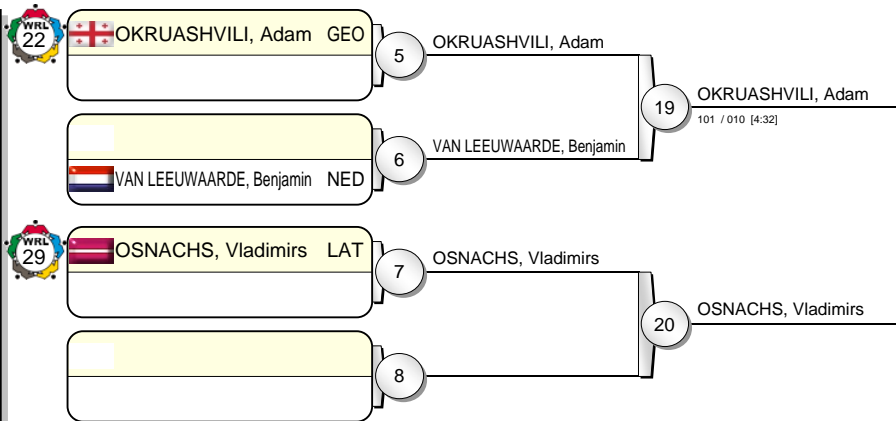

Pool C

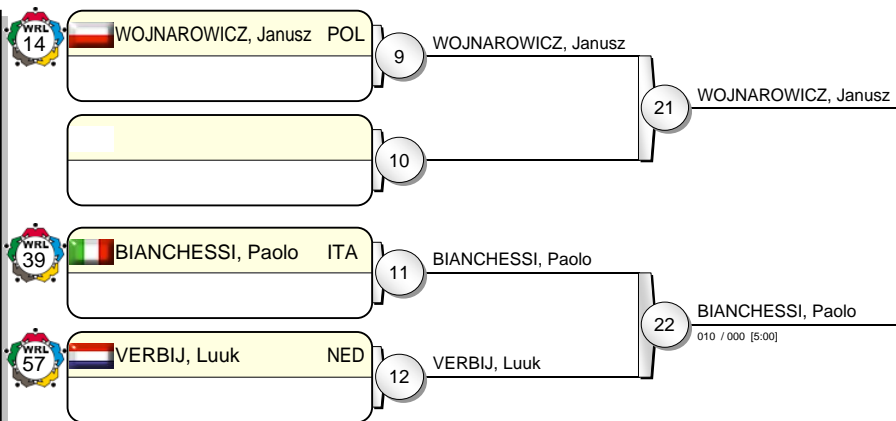

Pool D

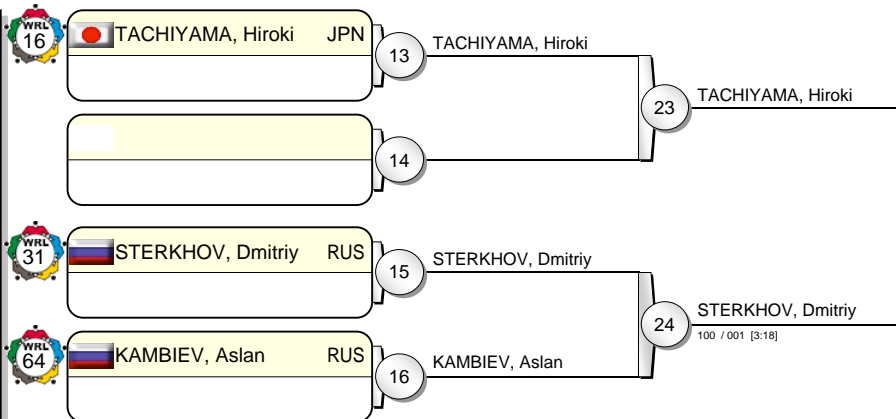

TACHIYAMA, Hiroki JPN 31  
010 / 100 [2:30]

OSNACHS, Vladimirs LAT 29  
000 / 110 [4:31]

## Results

1.	TACHIYAMA, Hiroki	JPN	
2.	OSNACHS, Vladimirs	LAT	
3.	BONDARENKO, Stanislav	UKR	
3.	BIANCHESSI, Paolo	ITA	
5.	MOMOSE, Masaru	JPN	
5.	OKRUASHVILI, Adam	GEO	
5.	WOJNAROWICZ, Janusz	POL	
5.	STERKHOV, Dmitry	RUS	



# IJF Grandprix Rotterdam 2010

(NED Rotterdam, 15-17 October 2010)

# -48 kg

21 Judoka

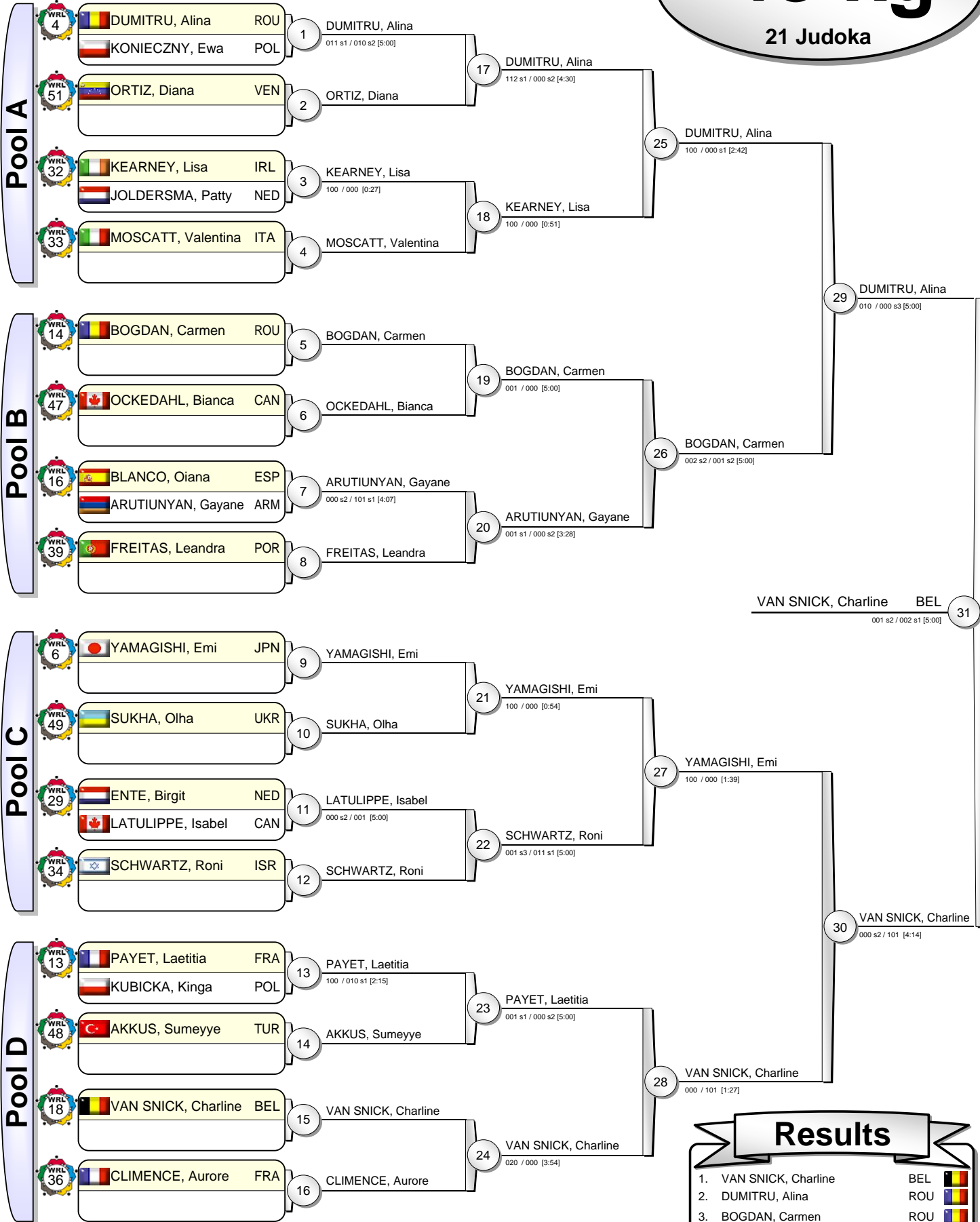

VAN SNICK, Charline BEL 31  
001 s2 / 002 s1 [5:00]

VAN SNICK, Charline BEL 30  
000 s2 / 101 [4:14]

## Results

- VAN SNICK, Charline BEL
- DUMITRU, Alina ROU
- BOGDAN, Carmen ROU
- YAMAGISHI, Emi JPN
- KEARNEY, Lisa IRL
- ARUTIUNYAN, Gayane ARM
- SCHWARTZ, Roni ISR
- PAYET, Laetitia FRA







# IJF Grandprix Rotterdam 2010

(NED Rotterdam, 15-17 October 2010)

# -52 kg

16 Judoka

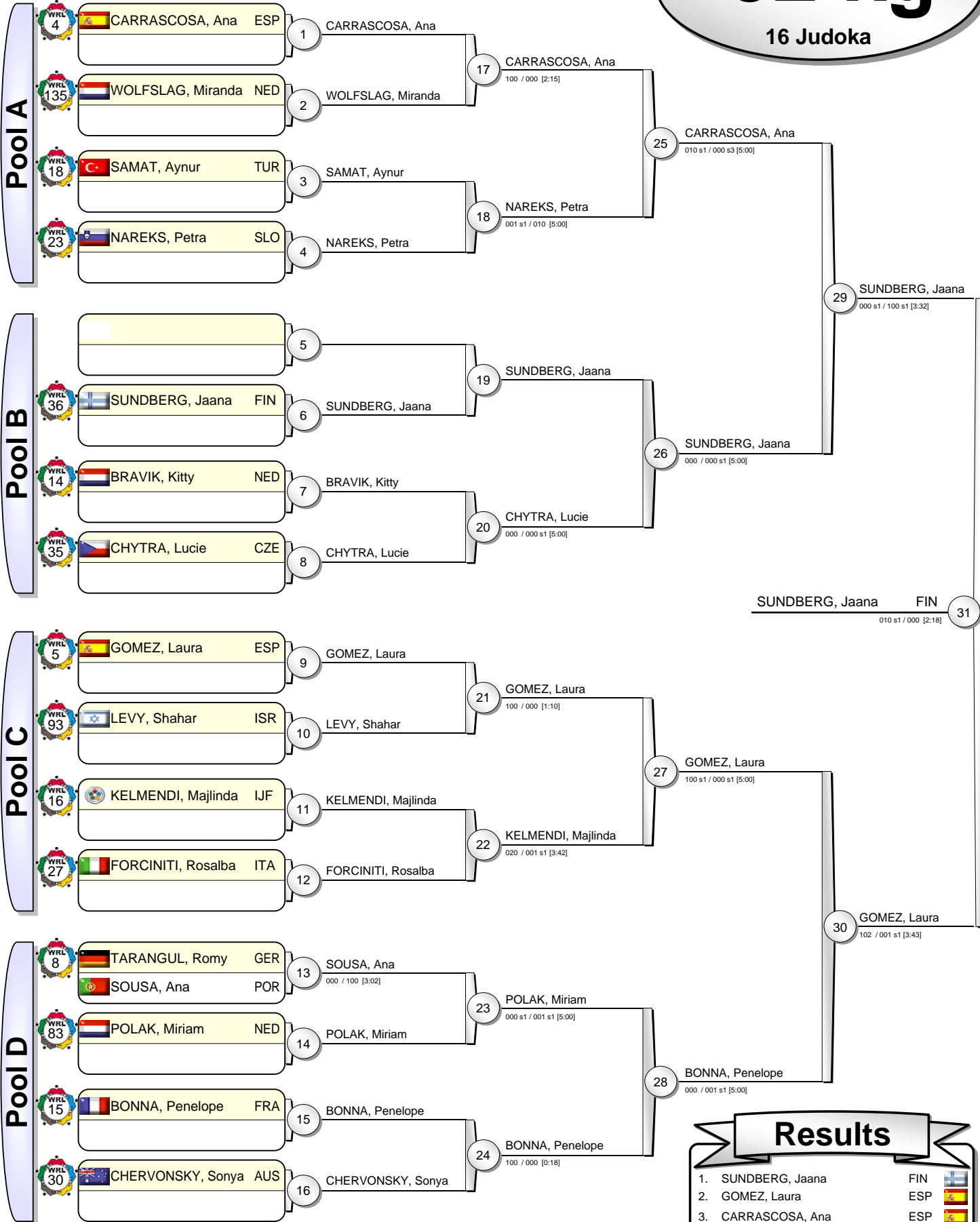

SUNDBERG, Jaana FIN 31  
010 s1 / 000 [2:18]

## Results

- |                       |     |  |
|-----------------------|-----|--|
| 1. SUNDBERG, Jaana    | FIN |  |
| 2. GOMEZ, Laura       | ESP |  |
| 3. CARRASCOSA, Ana    | ESP |  |
| 3. BONNA, Penelope    | FRA |  |
| 5. NAREKS, Petra      | SLO |  |
| 5. CHYTRA, Lucie      | CZE |  |
| 5. KELMENDI, Majlinda | IJF |  |
| 5. POLAK, Miriam      | NED |  |



# IJF Grandprix Rotterdam 2010

(NED Rotterdam, 15-17 October 2010)

# -57 kg

20 Judoka

Pool A

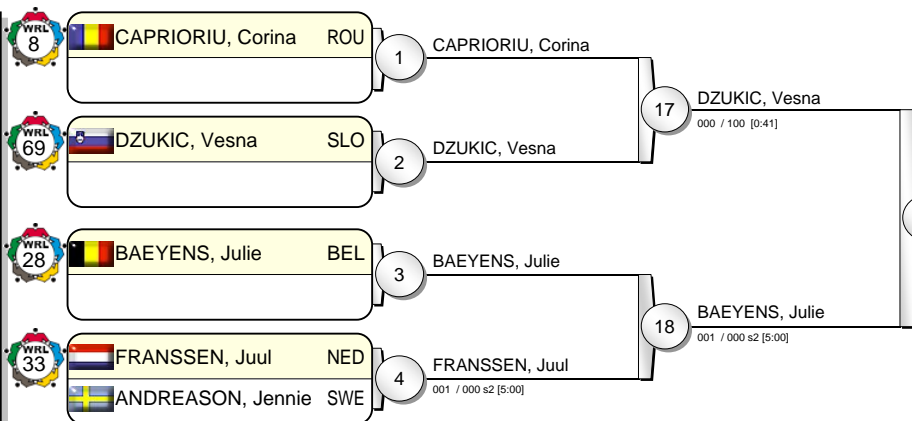

Pool B

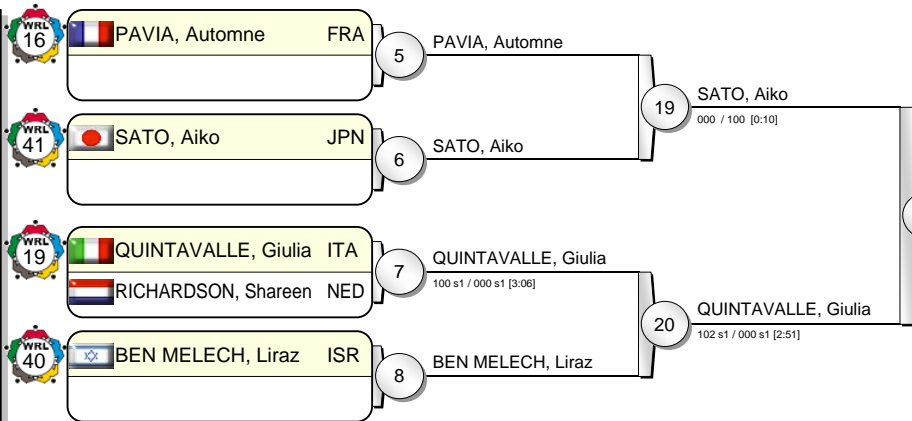

Pool C

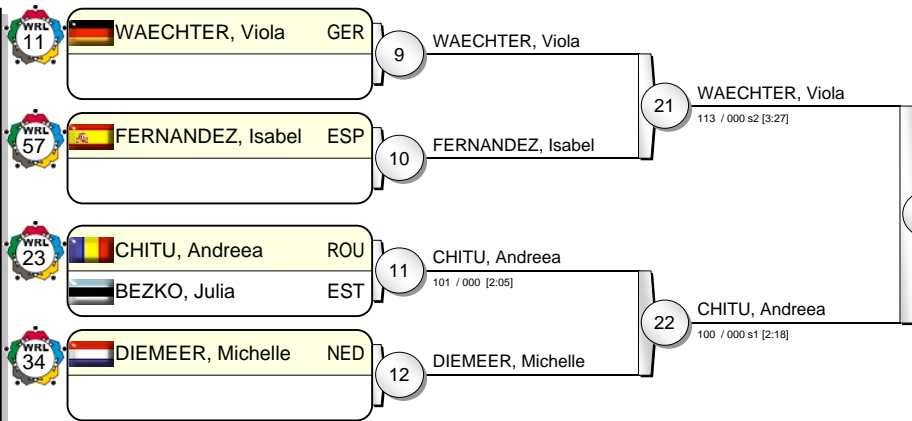

Pool D

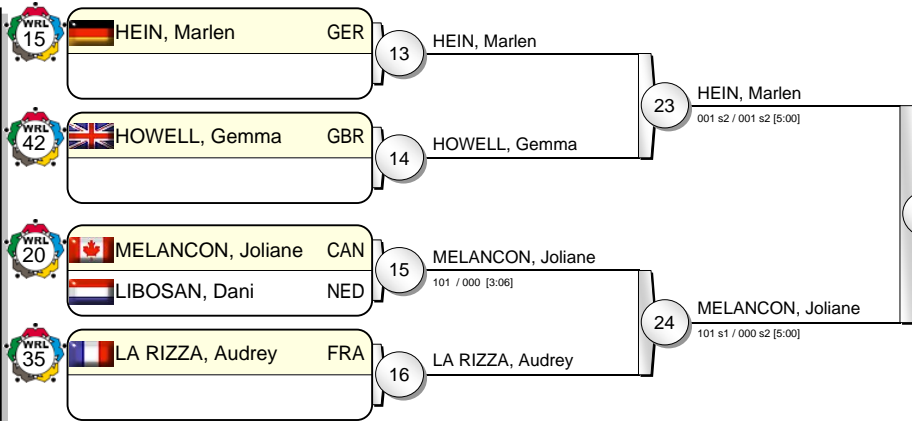

SATO, Aiko JPN (31) 100 / 000 [0:10]

## Results

- |                        |     |  |
|------------------------|-----|--|
| 1. SATO, Aiko          | JPN |  |
| 2. HEIN, Marlen        | GER |  |
| 3. DZUKIC, Vesna       | SLO |  |
| 3. WAECHTER, Viola     | GER |  |
| 5. BAEYENS, Julie      | BEL |  |
| 5. QUINTAVALLE, Giulia | ITA |  |
| 5. CHITU, Andreea      | ROU |  |
| 5. MELANCON, Joliane   | CAN |  |



# IJF Grandprix Rotterdam 2010

(NED Rotterdam, 15-17 October 2010)

# -63 kg

19 Judoka

Pool A

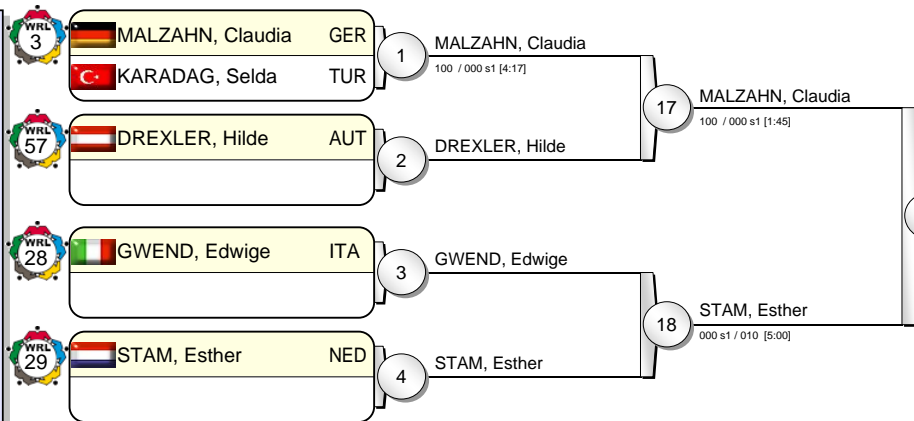

Pool B

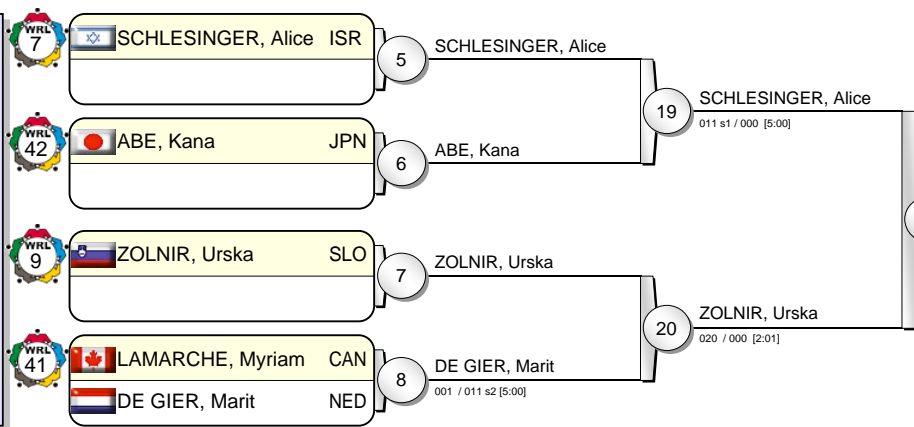

Pool C

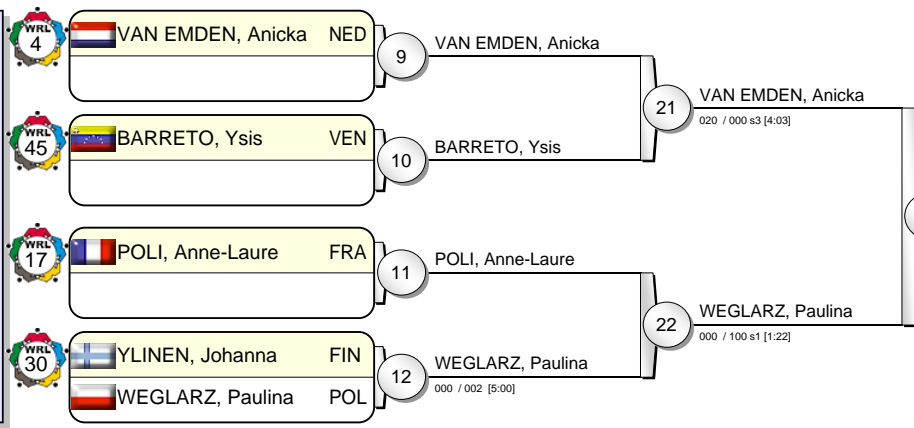

Pool D

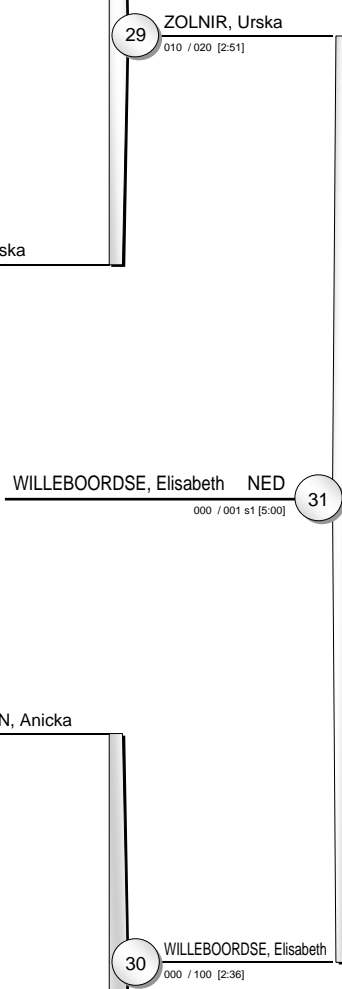
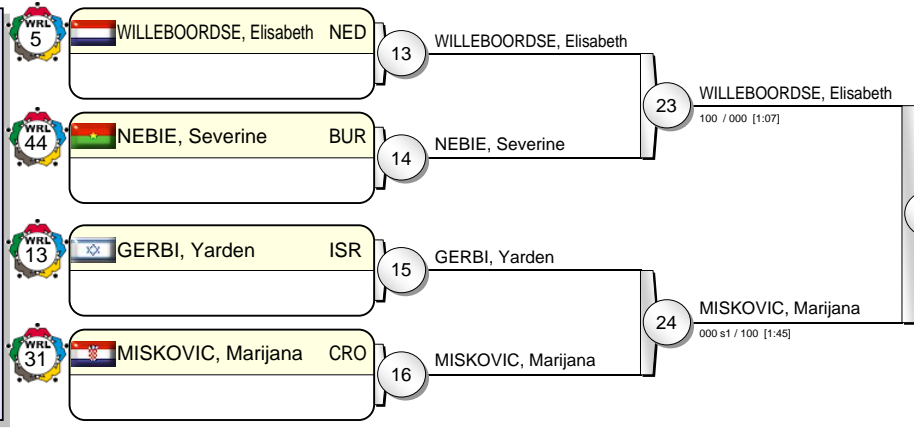

## Results

1. WILLEBOORDSE, Elisabeth NED
2. ZOLNIR, Urska SLO
3. MALZAHN, Claudia GER
3. VAN EMDEN, Anicka NED
5. STAM, Esther NED
5. SCHLESINGER, Alice ISR
5. WEGLARZ, Paulina POL
5. MISKOVIC, Marijana CRO





# IJF Grandprix Rotterdam 2010

(NED Rotterdam, 15-17 October 2010)

# -70 kg

16 Judoka

Pool A

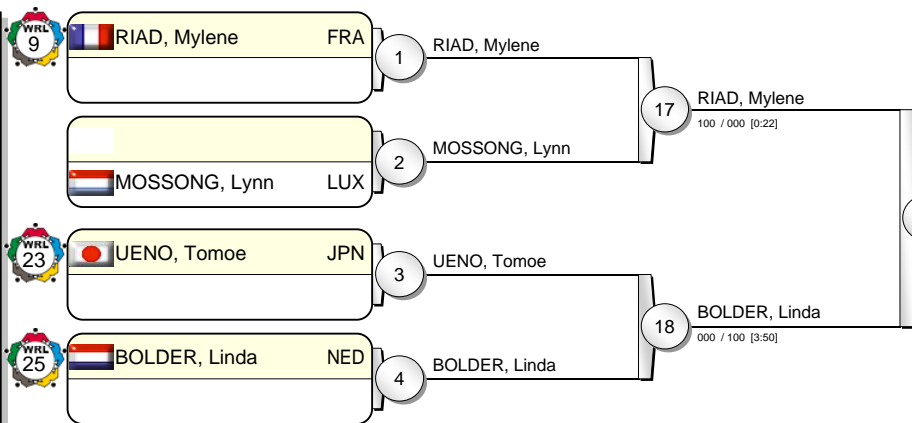

Pool B

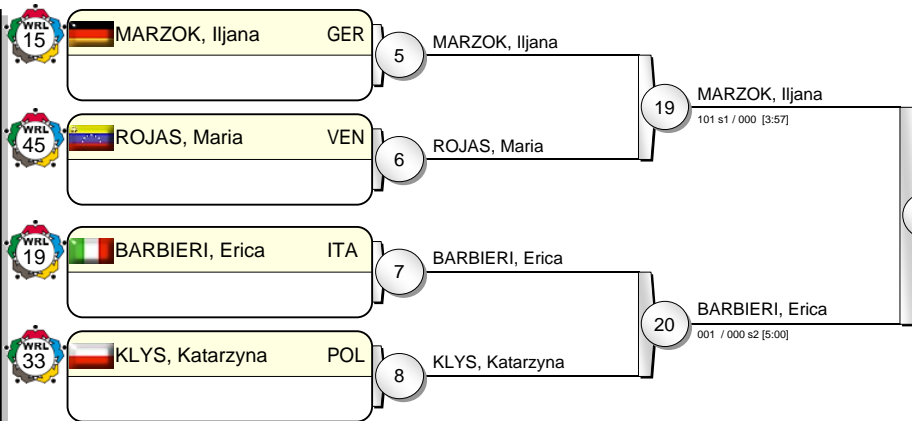

Pool C

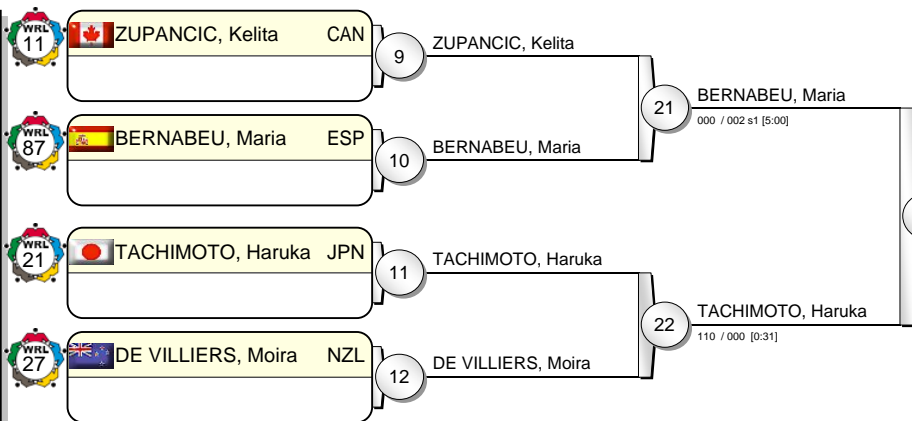

Pool D

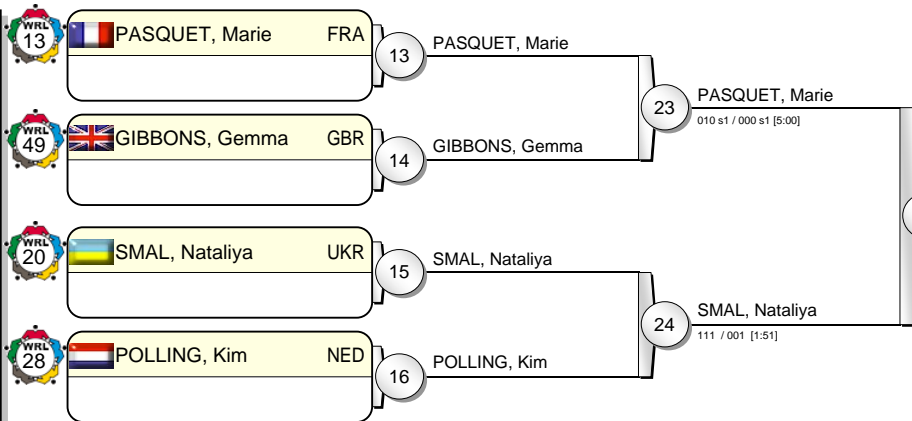

TACHIMOTO, Haruka JPN 31  
000 / 101 [2:52]

29 BARBIERI, Erica  
010 / 110 [4:28]

25 BOLDER, Linda  
000 s1 / 010 [5:00]

26 BARBIERI, Erica  
001 s1 / 021 s1 [4:58]

21 BERNABEU, Maria  
000 / 002 s1 [5:00]

27 TACHIMOTO, Haruka  
000 s1 / 100 [1:44]

22 TACHIMOTO, Haruka  
110 / 000 [0:31]

30 TACHIMOTO, Haruka  
010 / 000 [5:00]

23 PASQUET, Marie  
010 s1 / 000 s1 [5:00]

28 PASQUET, Marie  
110 s1 / 000 [2:12]

17 RIAD, Mylene  
100 / 000 [0:22]

18 BOLDER, Linda  
000 / 100 [3:50]

19 MARZOK, Iljana  
101 s1 / 000 [3:57]

20 BARBIERI, Erica  
001 / 000 s2 [5:00]

9 ZUPANCIC, Kelita

11 TACHIMOTO, Haruka

12 DE VILLIERS, Moira

13 PASQUET, Marie

14 GIBBONS, Gemma

15 SMAL, Nataliya

1 RIAD, Mylene

2 MOSSONG, Lynn

3 UENO, Tomoe

4 BOLDER, Linda

5 MARZOK, Iljana

6 ROJAS, Maria

7 BARBIERI, Erica

8 KLYS, Katarzyna

## Results

- |                      |     |  |
|----------------------|-----|--|
| 1. TACHIMOTO, Haruka | JPN |  |
| 2. BARBIERI, Erica   | ITA |  |
| 3. BOLDER, Linda     | NED |  |
| 3. PASQUET, Marie    | FRA |  |
| 5. RIAD, Mylene      | FRA |  |
| 5. MARZOK, Iljana    | GER |  |
| 5. BERNABEU, Maria   | ESP |  |
| 5. SMAL, Nataliya    | UKR |  |



# IJF Grandprix Rotterdam 2010

(NED Rotterdam, 15-17 October 2010)

# -78 kg

18 Judoka

Pool A

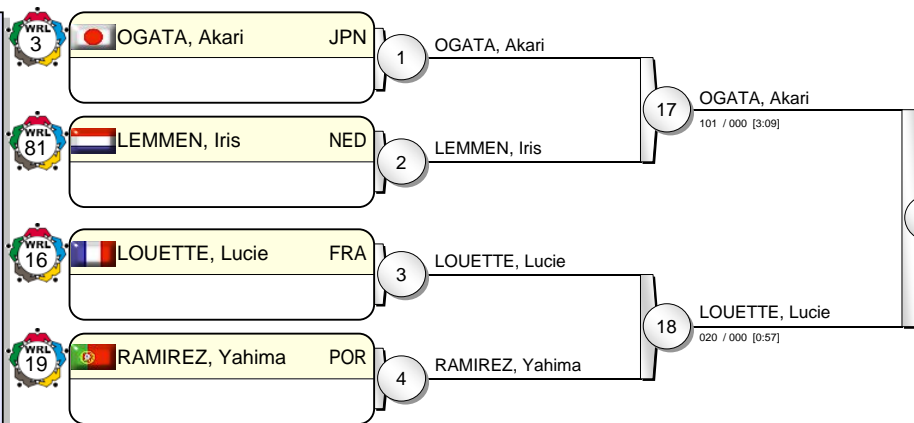

Pool B

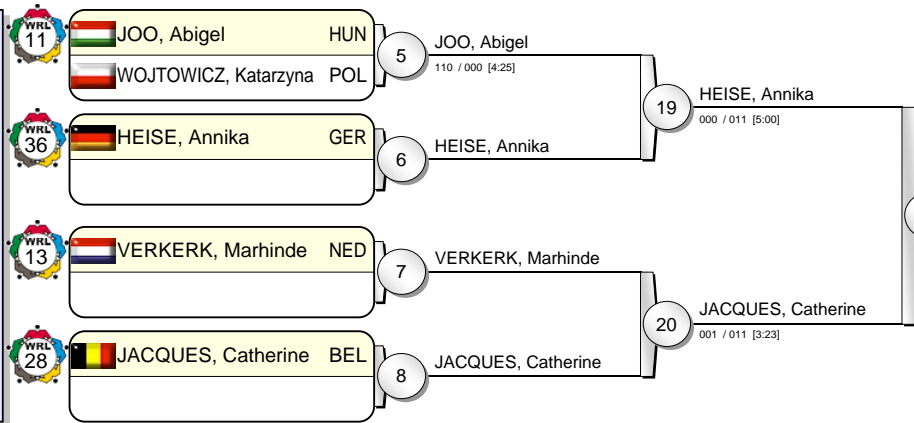

Pool C

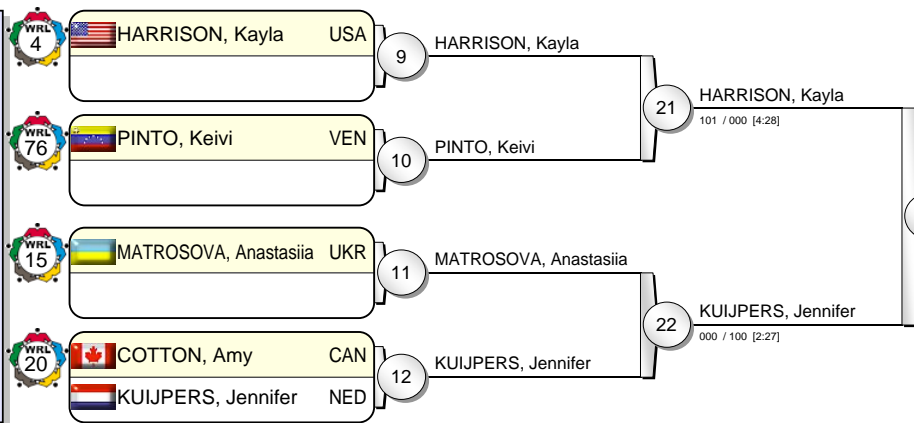

Pool D

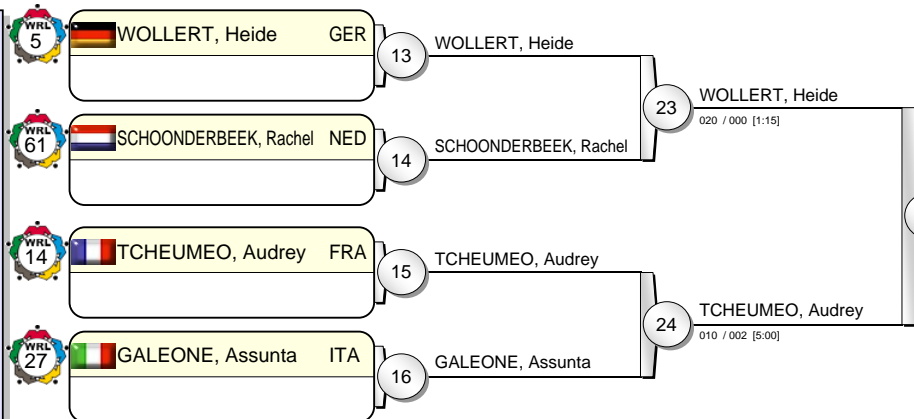

OGATA, Akari (JPN) 31-0 (3:20)

## Results

- |                       |     |  |
|-----------------------|-----|--|
| 1. OGATA, Akari       | JPN |  |
| 2. TCHEUMEO, Audrey   | FRA |  |
| 3. JACQUES, Catherine | BEL |  |
| 3. HARRISON, Kayla    | USA |  |
| 5. LOUETTE, Lucie     | FRA |  |
| 5. HEISE, Annika      | GER |  |
| 5. KUIJPERS, Jennifer | NED |  |
| 5. WOLLERT, Heide     | GER |  |





# IJF Grandprix Rotterdam 2010

(NED Rotterdam, 15-17 October 2010)

# +78 kg

12 Judoka

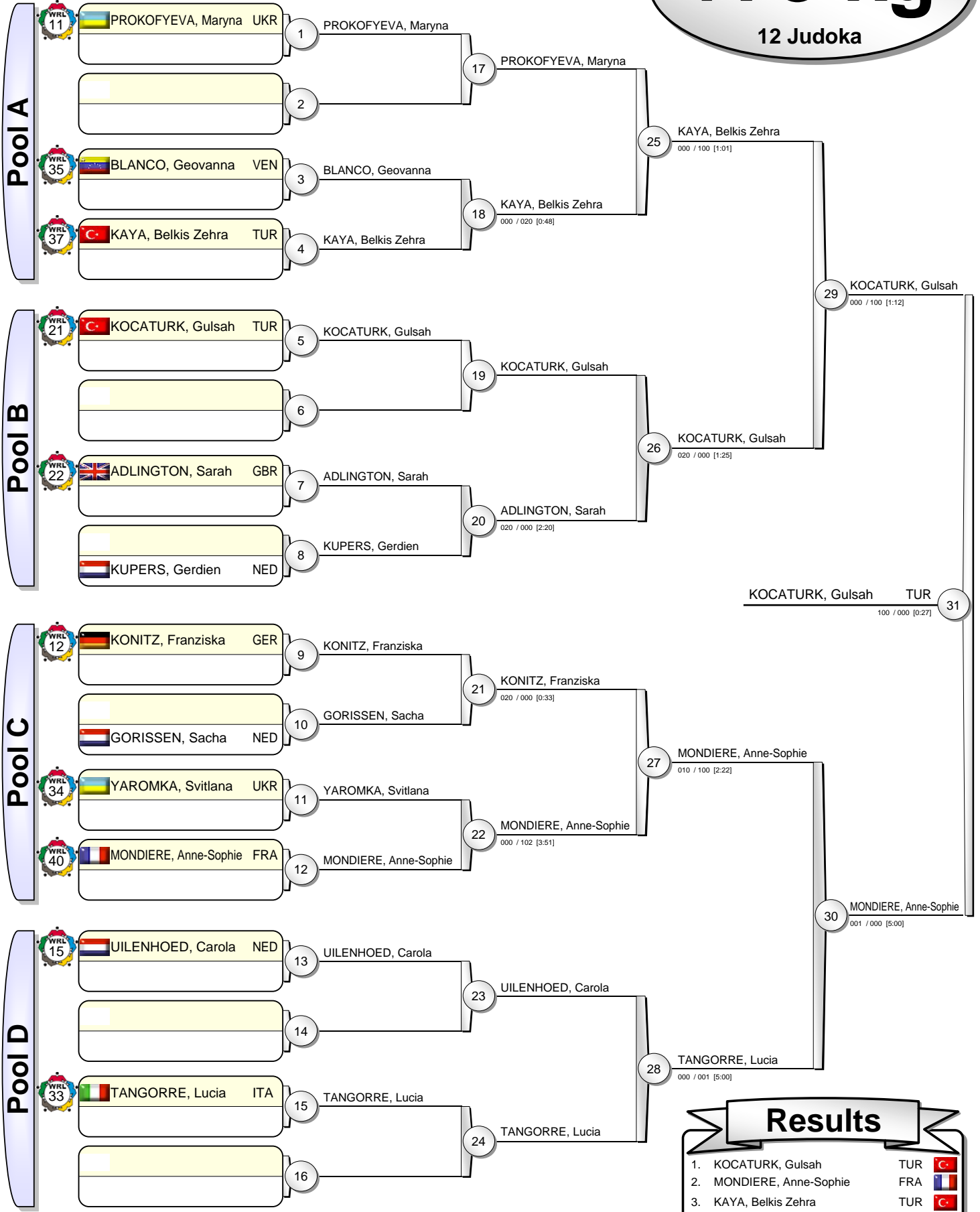

KOCATURK, Gulsah TUR 31  
100 / 000 [0:27]

## Results

- |                          |     |  |
|--------------------------|-----|--|
| 1. KOCATURK, Gulsah      | TUR |  |
| 2. MONDIERE, Anne-Sophie | FRA |  |
| 3. KAYA, Belkis Zehra    | TUR |  |
| 3. TANGORRE, Lucia       | ITA |  |
| 5. PROKOFYEVA, Maryna    | UKR |  |
| 5. ADLINGTON, Sarah      | GBR |  |
| 5. KONITZ, Franziska     | GER |  |
| 5. UILENHOED, Carola     | NED |  |